

# PIERCE

PULLING FOR YOU

OWNER'S MANUAL  
DUMP KITS  
DKLK / DKMK / DKHK



## REGISTER YOUR PRODUCT!

In order for us to best serve you,  
please register your product at  
[www.piercearrowinc.com/register](http://www.piercearrowinc.com/register).

### *Why register?*

- receive product updates via email
- receive maintenance reminders via email
- receive quick technical service help if you encounter a problem

## DISCLAIMER

The Pierce Dump Kit is a powerful machine and must be used with extreme care. Deviating from the manual's instructions may cause personal injury. You may lose your warranty if you do not follow the precautions and guidelines outlined in this manual. Keep this manual in a safe place to reference safety and installation instructions, maintenance guidelines and operating recommendations. The owner, operator, and installer must read the entire owner's manual before operating the dump kit. For a digital copy of the manual visit [www.piercearrowinc.com/pierce-manuals](http://www.piercearrowinc.com/pierce-manuals).

## SAFETY WARNINGS

- Read the installation manual before proceeding.
- Disconnect the vehicle battery before welding.
- All wires must be supported by the truck frame. Wires connected to the bed are hazardous.
- Never exceed the weight limit of your equipment. Refer to your vehicle's owner's manual for more information.
- Installation of the included 200 amp breaker is required to prevent electrical shorts.
- When raising the bed, use an overhead hoist or body props. Be aware, injury can occur if the bed is not properly secured.
- Only weld at the rear of the chassis frame. Do not weld anywhere forward of the rear spring hangers in order to prevent cracks from developing in the frame and possible weak spots during the welding process.
- Secure all electrical lines every 12"-16" with zip ties.

## VIDEO GUIDE

Sometimes you need more than an installation guide to show you how the install is done. We hope our four part video guide on YouTube will help answer many of your questions. If you need extra assistance or just have a question, feel free to call us at 800-658-6301.

# 1

View how to begin your installation.



# 3

View how to finish your installation.



# 2

View how to wire your installation.



# 4

View a customer testimonial.



VISIT [YOUTUBE.COM/PIERCEARROWINC](http://YOUTUBE.COM/PIERCEARROWINC) FOR THE 4-PART INSTALLATION VIDEO SERIES

# DUMP KIT CONTENTS

	DKLK	DKMK	PART	QTY
SCISSOR ASSEMBLY (PRE-ASSEMBLED)	B231	A496	Scissor Top	1
	A218	A5003	Scissor Lower Arm Left and Right	2
	B230	B478	Crossmember	1
	A2283	A4734	Shaft A [5T - 7.5"] [7.5T - 9.25"]	1
	A2285	A4731	Shaft B [5T - 13.5"] [7.5T - 15"]	1
	A2282	A4735	Shaft C [5T - 19.5"] [7.5T - 21.5"]	1
	P05314	P046514	Hydraulic Cylinder	1
	SPRP221	SPRP221	7/32" x 2.5" Roll Pin	6
CHASSIS FRAME PARTS	A4952	A5012	Left Frame Hinge	1
	A4953	A5013	Right Frame Hinge	1
	A492	A492	Frame L Bracket	2
	A494	A494	Guides	2
	A2286	A4734	Shaft D [5T - 9.5"] [7.5T - 9.25"]	2
SILL PARTS	B2292	B5022	Left Sill Hinge	1
	B2293	B5023	Right Sill Hinge	1
	A219	A219	Sill Supports	2
HARDWARE	0115107	0115107	3/8" - 16 x 1.25" G5 Hex Head Bolts	2
	0144580	0144580	1/2" - 16 x 3" G8 Hex Head Bolts	10
	1133861	1133861	1/2" Flatwasher	10
	1137187	1137187	1/2" - 13 Locknut	10
	PS544	PS544	3/8" Lockwasher	2
	SPRP221	SPRP221	7/32" x 2.5" Roll Pin	4
	P046SP	P046SP	Safety Prop Kit	1
ELECTRICAL PARTS	76631	76631	200 amp Breaker	1
	PS501	PS501	#4 Welding Cable - Black	12'
	PS501R	PS501R	#4 Welding Cable - Red	12'
	PS006	PS006	5/16" Battery Eye	6
	PS525	PS525	On-Off-On Toggle Switch	1
	A502	A502	18/3 Ribbon Wire	12'
	PS006	PS006	#4 5/16" Terminals	2
	852105	852105	#10 Crimp-On Terminals	1
	852565	852565	5/16" Crimp-On Terminals	3
	894005	894005	1/4" Female Disconnect	1
422005	422005	Butt Connector Terminal	1	
HYDRAULIC PARTS	P19414	P19414	3/4" x 1/4" 90° Swivel O-Ring Fitting	1
	143	143	3/8" Male x 1/4" Female 90° Swivel Fitting	1
	P050H	P050H	Hydraulic Hose	5'
	PM3196P	PM3196P	12V Monarch Pump	1

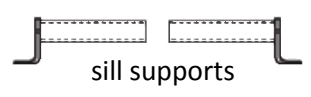
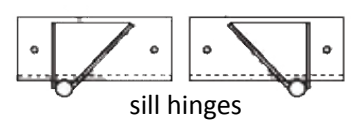
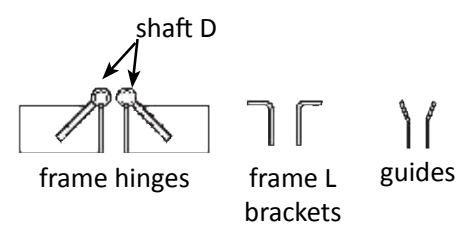
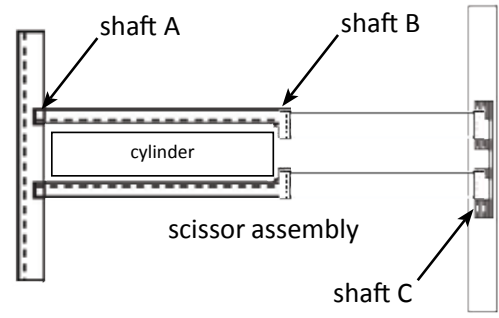

# INSTALLATION

## BEFORE BEGINNING

To reach maximum kit capacity and lift, a few questions must be asked:

- What is the bed length?
- How much overhang past the frame can I have?
- What is the optimal dump angle for my application?

## CHOOSING THE LIFT ANGLE

The bed length and overhang length effect the capacity of your kit. Refer to the table below.

	OVERHANG	8' BED	10' BED	12' BED
DKLK	0"	4.75 T	3.75 T	3 T
	12"	5 T	4.75 T	3 T
	24"	-	5 T	4.75 T
	36"	-	-	5 T
DKMK	0"	7 T	6.5 T	6 T
	12"	7.5 T	7 T	6.5 T
	24"	-	7.5 T	7 T
	36"	-	-	7.5 T

*Example:* If you require the maximum capacity for a medium duty kit, you must have:

- 8' bed with 12" overhang, *or...*
- 10' bed with 24" overhang, *or...*
- 12' bed with 36" overhang

## REMOVE WIRING AND ATTACHMENTS

- Remove all attachments holding the sill and bed to the truck frame including electrical wiring, fuel, hydraulic or air lines.
- All wires must be supported by the truck frame.

## CHASSIS SHORTENING & REAR HINGE PLACEMENT

- Shorten the chassis in order to create as much overhang as possible. A greater overhang past the hinges gives a counter lever effect and makes, in essence, the dump kit stronger.
- Cut the frame at a 45° angle so that there is hinge pin clearance above the cut. (*figure 1*)

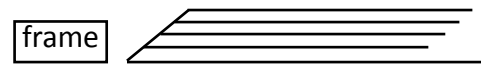

↑ *figure 1: Cut frame at 45° angle.*

- There should be enough metal to tack weld the frame hinge to the truck chassis frame.
- Connect the sill hinge to the tack welded frame hinge using shaft D. Secure with 7/32" x 2 1/2" roll pins. (*figure 2*)

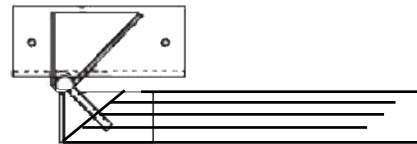

↑ *figure 2: Connect sill hinge to frame hinge.*

**NOTE:** Only weld at the rear of the chassis frame. Do not weld anywhere forward of the rear spring hangers in order to prevent cracks from developing in the frame and possible weak spots during the welding process.

**NOTE:** From the front rear spring hanger to the cab, all parts will be bolted to the frame.

## SCISSOR ASSEMBLY PLACEMENT

Now that the frame hinge location is determined, the scissor assembly (pre-assembled) placement must be evaluated.

- Measure from the frame hinge pin toward the cab. Mark 5'8" and 6'6". The scissor assembly crossmember and frame L bracket can be placed within this area. (*figure 3, next page*)

## INSTALLATION (continued)

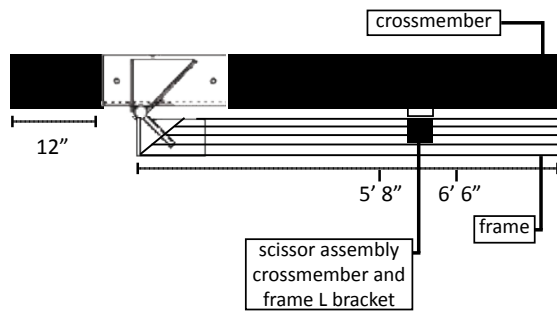

↑ figure 3: Choose the scissor placement.

- Keep in mind an 8' bed must overhang at least 12" from the frame hinge to reach full capacity on a medium duty kit.

**NOTE:** Desired bed height and lift capacity are determined by the placement of the crossmember. Chassis construction may dictate crossmember location.

- Bolt the frame L brackets to the chassis frame at the center of your measurement using grade 8, 1/2" bolts and self locking nuts. (figure 4)

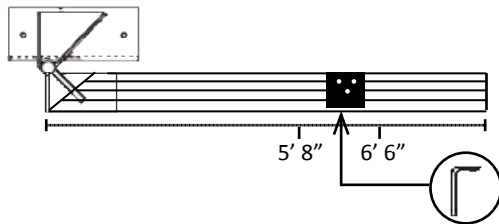

↑ figure 4: Bolt L brackets to chassis frame.

**NOTE:** The front filler hose may help determine scissor location and bed height.

### BED HEIGHT (Chevy installations only)

- Installations to a Chevy may require several considerations. The location of the scissor assembly will be determined by the front filler hose.
- Also, the thickness of the hose will require that the bed be installed with two or more inches of clearance.

### CROSSMEMBER MODIFICATIONS

- The scissor assembly crossmember comes extra long to fit various chassis widths.
- Cut the crossmember with enough room to run a welding bead.
- Tack weld the crossmember to the frame L bracket. Do not weld the crossmember directly to the chassis frame. (figure 5)

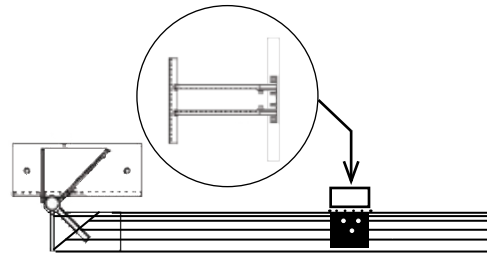

↑ figure 5: Weld crossmember to L bracket.

### SILL SUPPORT INSTALLATION

Sill supports slip into the scissor assembly tubing and support the truck bed. Sill support bolt location is determined by the bed's sill construction. (figure 6) Modification may be required. Examples include:

- **Notching:** The bed crossmembers may interfere with the kit.
- **Cutting:** If bed height is an issue, cut the sill support to fit within the sill.

**NOTE:** Do not weld the sill supports to the sill.

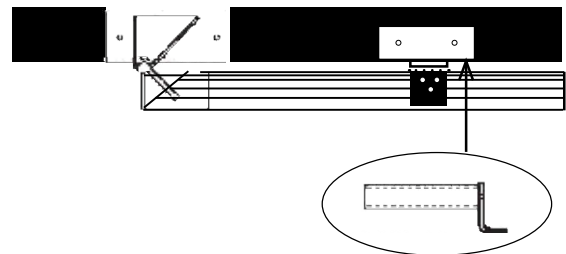

↑ figure 6: Install sill supports.

## INSTALLATION (continued)

### DRY FIT & UNDER BED MODIFICATIONS

- Before final welding, dry fit the bed to ensure proper bed alignment and any clearance issues.
- If you have a 10' bed with a 60" cab to axle, or a 12' bed with a 84" cab to axle, under bed crossmember trimming will be required. A dry fit will determine any issues.
- During the dry fit, notch the sill support and sill hinge holes for drilling. (figure 7)
- Remove the bed, drill the sill support and sill hinge holes.
- Dry fit again to ensure bolt hole alignment.

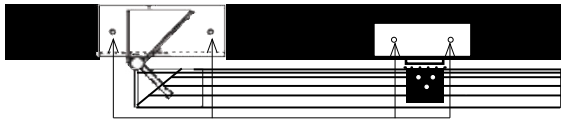

↑ figure 7: Notch sill support and hinge holes.

### FINAL WELDING & BOLTING

- Complete the welding of the crossmember to the frame L bracket.
- Bolt the sill support to the truck sill using the 1/2" bolts, flat washers and locking nuts.
- Bolt guides to the truck frame or weld to accessory but do not weld to the frame. (figure 8)

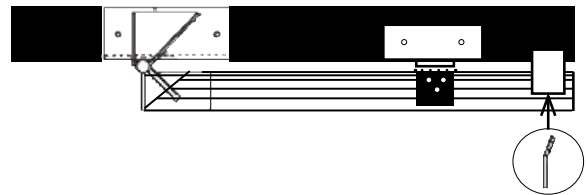

↑ figure 8: Bolt guides to truck frame.

### HYDRAULIC CONNECTIONS

- Unscrew and remove the coil on the pump.
- Use Teflon paste (do not use Teflon tape) around the fitting threads.
- Connect one fitting to the pump and one to the cylinder.

**NOTE:** Be sure the pump fitting faces the cylinder fitting. This will ensure the hose does not contact any moving parts.

- Run the hydraulic hose to the cylinder fitting and pump fitting.
- Return the coil to the pump.
- Fill the pump with automatic transmission fluid in warm climates. In colder climates, fill with military standard MIL-H-5606 fluid.

## BREAKER CONNECTIONS

Installation of a breaker (figure 9) is required for your equipment's safety. We use a 200 amp breaker.

The breaker has two positive connections that connect to the pump's solenoid and the vehicle's battery. Attach the jumper cable's ground clamp to a good ground source to ground your pump. Attach the hot clamp directly to the post on the top of your motor, careful not to touch any metal parts. If your motor does not run or runs sluggish, it will need to be replaced.



← figure 9: 76631 breaker

# WIRING DIAGRAMS

All PIERCE dump kits come with a power up / gravity down Bucher pump.

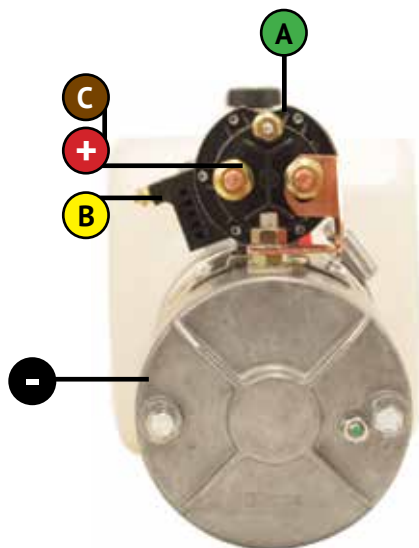

PM3196P Power Up / Gravity Down Bucher Pump

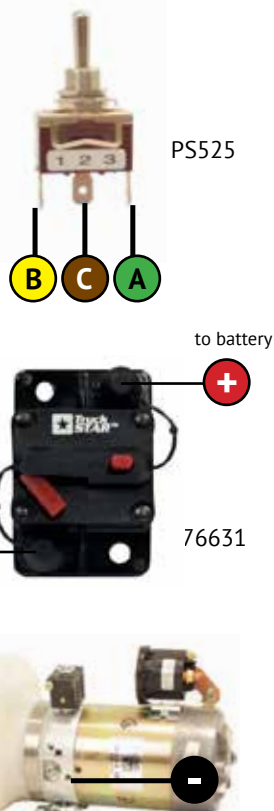





## PUMP SPECIFICATIONS

- 6 qt poly tank
- Reservoir is 6.7" x 6.7" x 13"
- 1.25 gpm at 1,750 psi
- Horizontal mount

Installation of a 200 amp breaker (76631) is highly recommended.

Use #4 cable for all connections.

Secure the battery cable with zip ties every 12".

-  GREEN TO SMALL SOLENOID POST
-  YELLOW TO PUMP COIL
-  BROWN TO POSITIVE SOLENOID POST
-  RED TO + BATTERY
-  BLACK TO - BATTERY  
*Use ground on side of motor. The ground bolt is supplied.*

For applications requiring a dual action pump, the PM3551 is recommended.

## PUMP SPECIFICATIONS

- 6.7" x 6.7" x 15" poly reservoir (540 cu. in. usable)
- 9/16th's SAE o-ring ports
- Adjustable relief at 2,500 psi
- Low pressure relief at 600 psi
- 2.00 gpm PCFC to control down speed
- Horizontal mount
- Delivers 1.25 gpm at 1750 psi





Use #16 or #18 cable for all connections.

Secure the battery cable with zip ties every 12".

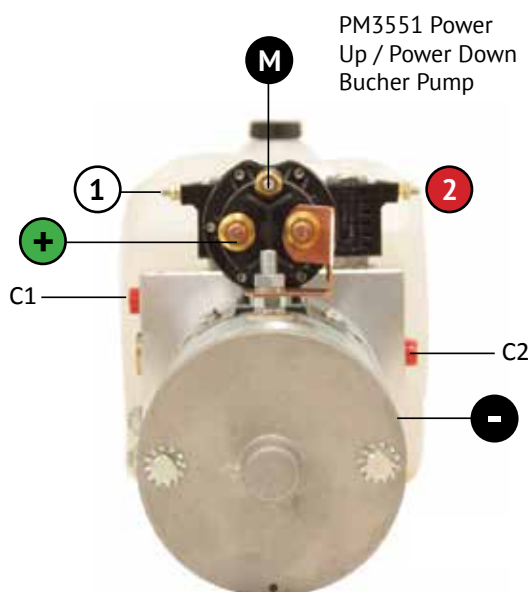
C1 is the high pressure port. The main relief is set at 2500 psi. C2 is the low pressure port, and that relief is set at 500 psi.

Compatible with the CP077K remote. The PS525 toggle switch included in the kit will not work.



-  12V
-  COIL 1
-  COIL 2
-  MASTER
-  GROUND



CP077K Remote

## SAFETY PROP INSTALLATION

- Install the safety prop with the bed in the up position so that you can adjust where the prop needs to mount.
- The safety prop base will bolt to the main frame of the bed using two 1/2" G8 bolts (supplied).
- Allow the prop to hang and lower the bed until the prop reaches where the base would mount. This will ensure that the base is going to line up with safety prop.
- Prop is only intended for use on an empty bed.

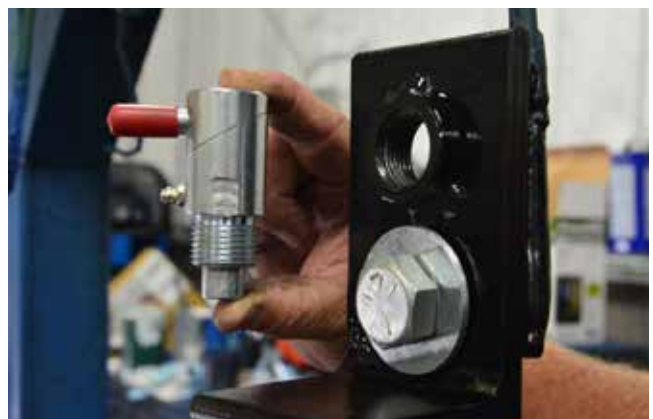
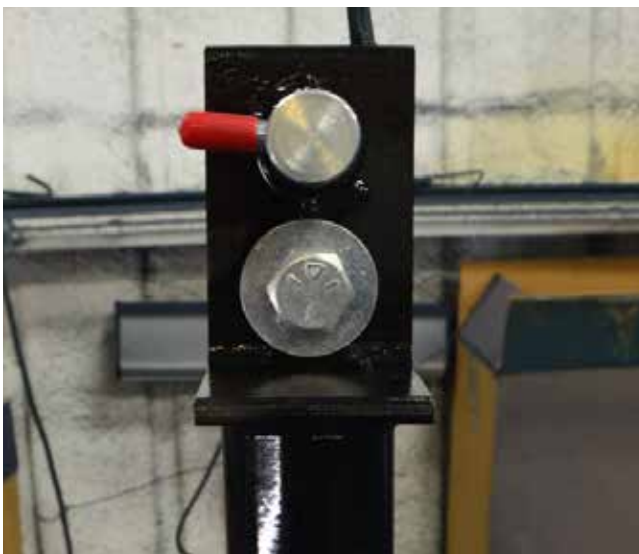



# LIMITED WARRANTY

Pierce Arrow Inc. warrants that the goods, equipment, and merchandise manufactured by Pierce Arrow Inc. are free from defects in material and workmanship. The limited warranty includes replacement or repair of defective mechanical and electrical parts for a period of one year from the date of shipment by Pierce Arrow Inc.

## OBTAINING WARRANTY SERVICE

---

Pierce Arrow Inc. must be notified of any defect before repair or replacement may be granted. The merchandise must be delivered by the purchaser to Pierce Arrow Inc. in Henrietta, Texas at the purchaser's expense. Any repairs not made by Pierce Arrow Inc. are not covered by the limited warranty and are the responsibility of the purchaser.

Pierce Arrow Inc. reserves the right to repair or replace defective parts or products in its sole discretion. The cost of any repairs not covered by the warranty will be charged to the purchaser.

## EXCLUSIONS

---

All Pierce products are manufactured for a specific intended purpose. The Pierce Arrow Inc. limited warranty does not cover, and Pierce Arrow Inc. is not liable for, damage arising from any use other than the specific intended use of each product.

All coolers manufactured by Pierce are warranted for general cooling, and are not guaranteed to produce cooling sufficient for any specific purpose or for specific temperature. Pierce is not liable for any injury or damage arising from insufficiently cooled objects placed in the cooler, including but not limited to medications and perishables.

The Pierce Arrow Inc. limited warranty does not cover:

- Ongoing maintenance parts or repair due to normal wear and tear, and
- Any change or defect due to accident, misuse or any use for which the equipment was not intended, improper or unauthorized repair, failure to provide regular maintenance, and deterioration due to weather or road conditions.

Purchasers should consult their owner's manual for safety, installation, operation, and maintenance guidelines.

The Pierce Arrow Inc. limited warranty does not cover purchaser's cost of labor, transportation, shipping damages, installation or removal costs, down time, loss of profit or goodwill, or any other special, incidental, indirect, or consequential damages, concerning or related to any product or

part, whether based upon negligence, strict liability, breach of contract, breach of warranty, misrepresentation, or any other legal theory.

Merchandise manufactured by Pierce Arrow Inc. is not designed or intended for the movement of people and are not to be used in the operation of elevators or other improper uses. Any improper use of the product may void the warranty.

## OTHER MANUFACTURERS' WARRANTIES

---

Pierce Arrow Inc. makes no warranty, expressed or implied, to finished products manufactured or supplied by other manufacturers, and sold by Pierce Arrow Inc. to the purchaser, including but not limited to, any vehicle to which our product is affixed and any accessories. Such merchandise is subject to the manufacturer's warranty only, which will be provided upon request.

## CONDITIONS OF SALE

---

When placing an order with Pierce Arrow Inc., the terms and conditions provided for payment, shipping, delivery and claims create an agreement between the purchaser and Pierce Arrow Inc. The agreement is to be performed in Clay County, Texas.

**RETURNS:** No returns are accepted without prior authorization. All items must be returned in their entirety. Please contact a sales representative for authorization. Upon authorization, returns must be shipped freight prepaid and may be subject to a 15% restocking fee. Please do not send returns COD. No returns will be accepted later than 30 days from the date of invoice.

**DAMAGED GOODS:** Pierce Arrow Inc. is not responsible for, and has no liability for:

- Damage arising during shipment
- Any change or defect due to accident, misuse or any use for which the equipment was not intended, improper or unauthorized repair, failure to provide regular maintenance, and deterioration due to weather or road conditions.

**CLAIMS:** Claims for breakage or damages during shipment must be made to the carrier at the time of delivery. If a signature is required, you must notify the driver and sign that there was damage. You must notify Pierce Arrow Inc. of the damage promptly so that a claim can be filed.

## ***Thank you for choosing Pierce!***

**We strive to offer 100% customer satisfaction on all our products. We are committed to excellent customer service because we are *pulling for you*.**

### **SHARE YOUR FEEDBACK**

*Are you 100% satisfied?*

- **If YES:** Please write a review on our Facebook page. [www.facebook.com/piercearrowinc](http://www.facebook.com/piercearrowinc)
- **If NO:** Call us at 800-658-6301 or let us know how we can help at [www.piercearrowinc.com/contact-us](http://www.piercearrowinc.com/contact-us)

### **STAY IN TOUCH**

Pierce Arrow Inc.  
549 US Highway 287 South  
Henrietta, Texas 76365

Toll Free: (800) 658-6301  
Local: (940) 538-5643  
Fax: (940) 538-4382

[www.piercearrowinc.com](http://www.piercearrowinc.com)  
[www.youtube.com/piercearrowinc](http://www.youtube.com/piercearrowinc)